

Los cielos lineales U consisten en paneles dispuestos paralelamente soportados por un portapanel universal. Su aspecto varía dependiendo de su modulación. Su apariencia es regular y plana, con una separación entre paneles de 20mm (cantería). Son particularmente útiles donde se requiera un cielo altamente decorativo y liviano.

CIELOS U

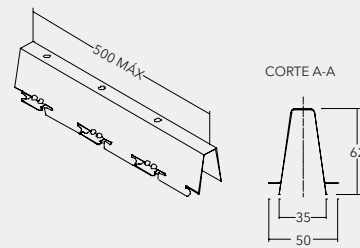

TIPOS DE CIELOS U

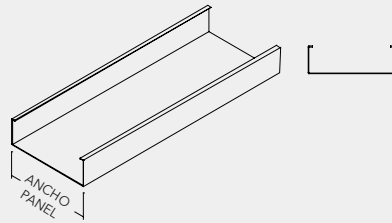
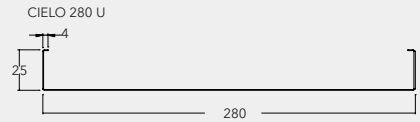
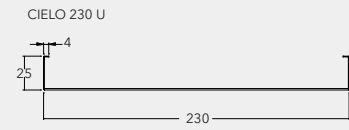
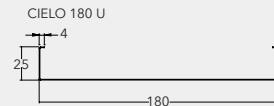
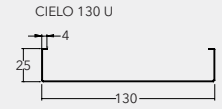
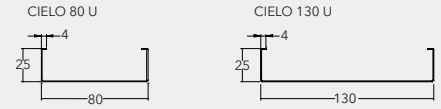

DESCRIPCIÓN TÉCNICA

PRODUCTO	MATERIAL	ESPESOR (mm)	PESO (kg/m ²)	RENDIMIENTO (mm)	LARGO (mm)
CIELO U 80	ALUZINC	0,5	5,28	10	6000
CIELO U 130			4,80	6,6	
CIELO U 180		0,6	5,56	5	
CIELO U 230			5,41	4	
CIELO U 280			5,25	3,3	

- Material: Aluminio y Aluzinc
- Uso: Cielos
- Terminación: Lisa y perforada
- Colores: Más de 100 colores estándar y especiales a pedido
- Largos: Según requerimiento de proyecto, se recomienda no sobrepasar los 6 metros

DETALLE REGISTRO PANEL U EN PORTAPANEL

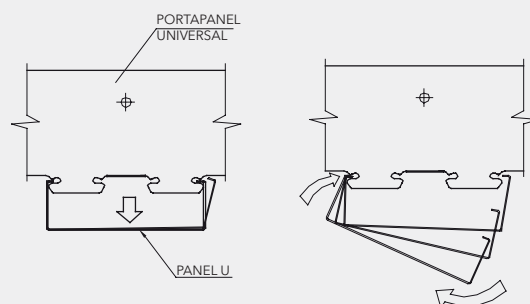

SISTEMA INSTALACIÓN

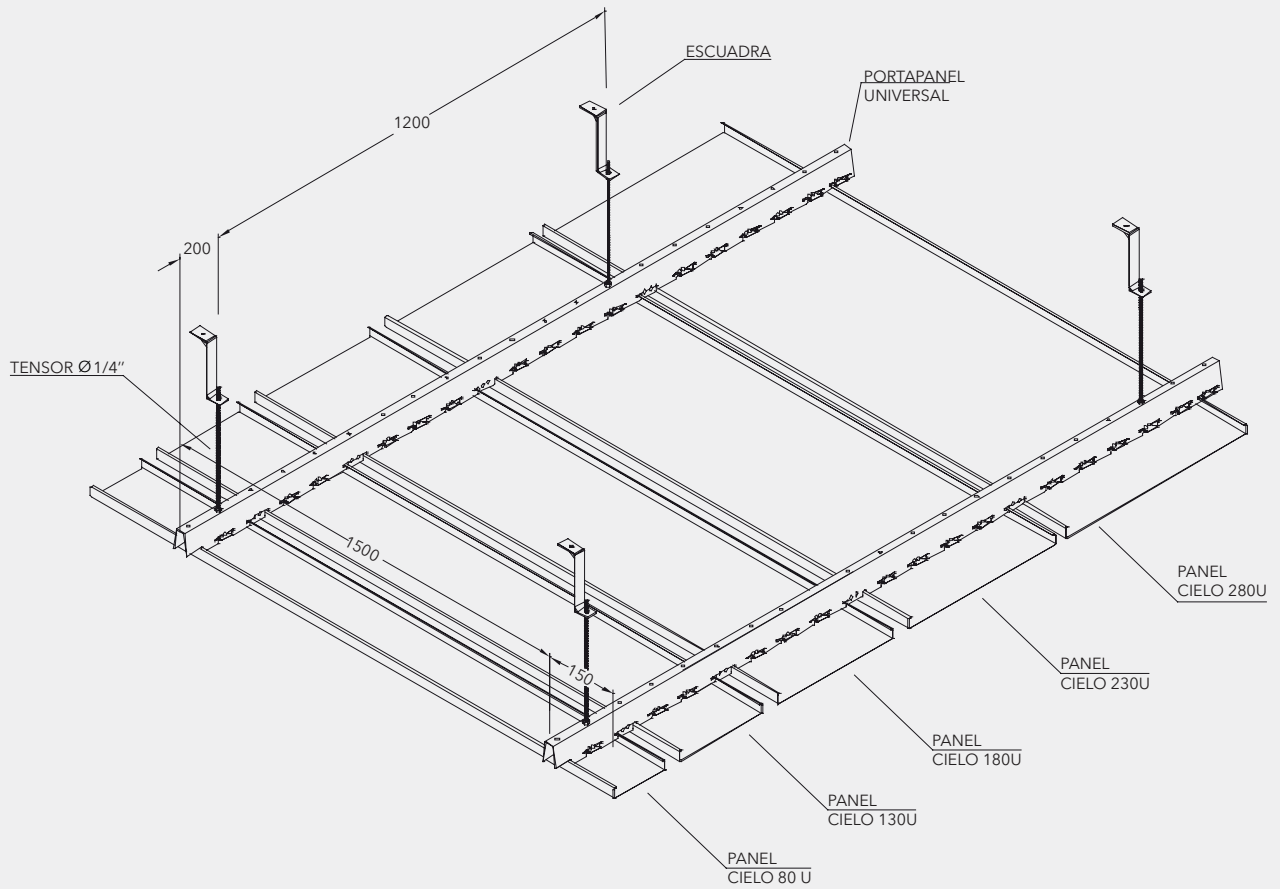

SISTEMA DE INSTALACIÓN PANEL 180 U

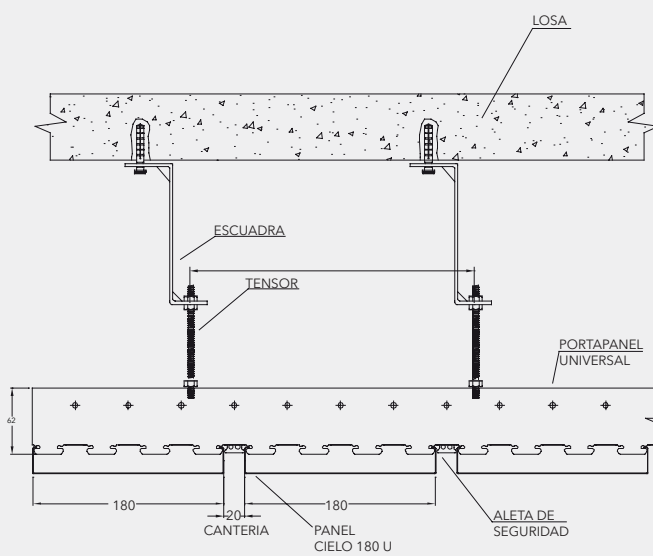

REMATE CONTRA MURO

